

USER MANUAL

PRESSURE MEASUREMENT

HOLYKEEL.COM

Monocrystalline Silicon Smart Pressure Transmitter Operation Manual



HK51



HK55



Preface

Thank you very much for purchasing our company's monocrystalline silicon transmitter products.

This manual provides a detailed introduction to the functions, wiring methods, setting methods, operating methods, and troubleshooting methods that can be implemented by the instrument. Before the instrument is put into operation, it is necessary to read this manual in detail and conduct specific operation after mastering correct usage method to avoid unnecessary losses caused by incorrect operation.

- ◆ Please read this manual carefully before using the instrument. The instrument can be installed, operated and maintained on premise of full understanding. Incorrect installation or operation may result in damage to the instrument or personal injury.

- ◆ The company promises there is no defects in materials and manufacturing processes in hardware and accessories that shall be provided when instrument is supplied. Starting from the date of purchase, the company will carry out unconditional free maintenance or free replacement for products that are indeed defective within the one-year warranty period if the company receives notification of such defects from users. The company guarantees lifetime maintenance for all products.

- ◆ In order to comply with the principle of sustainable development, the company reserves rights to modify performance parameters described in this manual without prior notice. The company also reserves rights to amend or revoke this manual without prior notice. When modification of certain performance parameters of the instrument may result in serious accidents, the company shall inform users in advance. The company will have a new version of instruction manual or improvement instruction for modified instrument. If the description in this manual is inconsistent with the actual product, please refer to the actual product.

- ◆ It is strictly forbidden to make any modification to the instrument! The company is not responsible for accidents caused by unauthorized modification of this product.

Content

1. Document information	05
1.1 Document function	05
1.2 Chart	05
1.3 Electric chart	05
2. Basic safety instruction	06
2.1 Personnel requirement	06
2.2 Misuse	06
2.3 Safety of working location	06
2.4 Operational safety	06
2.5 Dangerous zone	07
2.6 Product safety	07
2.7 Functional safety (optional)	07
3. Product performance description	08
3.1 Characteristics	08
3.2 Dimension Figure	10
4. Installation	12
4.1 Conventional installation instruction	12
4.2 On-site installation	12
4.3 Installation location	13
4.4 Installation in dangerous places	13
4.5 Notes for using explosive-proof transmitter	14
4.6 Measurement method	15
5. Wiring	17
5.1 Wiring device	17
5.2 Wiring method	17
6. Debugging	19
6.1 Local three-button debugging	19
7. Maintenance and troubleshooting of transmitter	21
7.1 Instrument maintenance	21
7.2 Troubleshooting	21
7.3 Display of error code	22

1. Document information







1.1 Document function

The document contains all the information required at different stages of the equipment life cycle: from product identification, arrival acceptance and storage, to installation, electrical connection and commissioning, and troubleshooting, maintenance and disposal.

1.2 Icon

Icon	Description
Danger	Danger! Dangerous status alert icon. Negligence will result in serious or fatal injury.
Warning	Warning! Dangerous status alert icon. Negligence will result in serious or fatal injury.
Be careful	Be careful! Dangerous status alert icon. Negligence will result in serious or fatal injury.
Attention	Attention! Alert information icons of operation and other effects. Does not cause personal injury.

1.3 Electric icon

Icon	Description	Icon	Description
	DC		AC
	DC and AC		Ground connection The operator recognizes by default that this ground terminal has been reliably grounded through the grounding system.
	Before the protective ground connection is made for subsequent electrical connections, it shall ensure that the terminal is grounded safely and reliably.		Equipotential connection It shall be connected to the factory grounding system: Use an equipotential bonding cable or a star grounding system connection, depending on national standards or company specifications.

2. Basic safety guidelines

2.1 Personnel requirements

Personnel performing installation, commissioning, diagnostics and maintenance operations shall meet the following requirements:

- ◆ Trained and qualified professionals shall have qualification to perform specific operations and tasks
- ◆ Authorized by the factory/operator
- ◆ Familiar with alliance / national regulations
- ◆ Professionals shall read and understand this Operating Instructions, supplementary documents and certificates before operation.

- ◆ Follow the operating guidelines and basic conditions

The operator shall meet the following requirements:

- ◆ Guided and authorized by the company according to mission requirements
- ◆ Follow the guidelines in this Operating Instructions

2.2 Error description

The manufacturer is not responsible for damage caused by improper use or non-designated use.

Verifying measurement conditions:

When measuring special fluids and cleaning fluids, the company is pleased to help verify the corrosion resistance of fluid connection parts, but do not guarantee or assume any responsibility.

2.3 Workplace safety

When operating equipment:

- ◆ Compliance with alliance / national regulations, personnel shall wear protective equipment.
- ◆ Turn off the power before wiring the device.

2.4 Operation safety

There is a risk of personal injury!

▲ Operate the equipment only under correct technical conditions and guaranteed safety conditions.

▲ It is the responsibility of the operator to ensure the equipment is operated without interference.

Modification of equipment

Unauthorized equipment changes are prohibited, which may result in unforeseen dangers:

▲ If changes are necessary, please consult our local sales center.

Repair

▲ Ensure operational safety and reliability.

▲ Only devices that are explicitly allowed:

▲ Only use original spare parts and accessories from our company.

2.5 Hazardous area

When the equipment is used in a hazardous area, measures shall be taken to eliminate the danger of personnel or equipment (e.g. explosion protection, pressure vessel safety):

- ◆ Refer to the nameplate to check and confirm that the ordered equipment is allowed to be used in a hazardous area.
- ◆ Comply with provisions in the supplemental documents, which is part of the Operation Manual.

2.6 Product safety

Measuring equipment is designed based on engineering practice and meets the most advanced and stringent safety requirements. It is safe to use through factory testing. The measuring equipment meets general safety requirements and legal requirements. It also meets requirements of the CE Directive in the Equipment CE Declaration of Conformity. The company ensures that the measuring equipment with CE mark complies with this requirement.

2.7 Functional safety (optional)

When using the device in an application with overall safety requirements, it is necessary to fully comply with requirements of Usage Instructions.

3. Product performance description

3.1 Features

(1) High accuracy

The differential pressure (β ow) transmitter can measure high accuracy within the measurement range of 0.1~40000kPa. Migration of positive and negative zero point is not necessary for linearity adjustment.

(2) Excellent environmental adaptability

Smart static pressure compensation and temperature compensation protect the transmitter from effects of temperature, static pressure and overpressure, and minimize on-site comprehensive measurement error.

(3) Flexible range compression

- ◆ Micro range (0...6kPa) ratio: 3:1
- ◆ Medium range ratio: 10:1
- ◆ Maximum range ratio: 10:1

(4) Excellent operability and ease of use

- ◆ 5 digits with backlit LCD digital display
- ◆ Multiple display functions (Pa, kPa, MPa, %, psi)
- ◆ Built-in three-button shortcut operation in-place adjustment function
- ◆ Available in various anti-corrosion materials
- ◆ Comprehensive self-diagnosis function

◆ Output signal: DC4~20mA+HART protocol

◆ Allowable load resistance: 0~600Ω (when DC 24V)

Note: A standard (250 Ω) load resistor is required to communicate with the handheld communicator.

◆ Power supply:

General purpose	DC10.5~45V
Intrinsically safe explosion-proof	DC10.5~26V

◆ Communication line conditions: Line length: up to 2km (0.75~1.25mm² control instrument cable, use twisted pair cable for more than 1km)

Load resistance: 250~600Ω

(DC 24V, including cable resistance)

Load capacitance: below 0.55mF

Load inductance: 3.3mH with power line spacing: 15cm or more

(Please avoid parallel wiring)

◆ Saturation current: upper limit 20.8mA

Lower limit 3.8mA

◆ Alarm current: upper limit 22.8mA

Lower limit 3.6mA

◆ Adjustment function: Zero point and full-scale point can be adjusted on site from the top three buttons of the outer casing or can be adjusted remotely by using conPfiguration software.

◆ Zero migration: Can migrate within the range of -20% to +20% of the maximum range

◆ Output mode: linear output

Square root output

(May achieve remote adjustment via conPfiguration software)

◆ Ambient temperature: -40~+85° C

(When Plling with Buorine oil: -10~+60° C)

◆ Storage temperature: -40~+90° C

◆ Weather resistance: DIN40040GPC

◆ EMC applicable standard: EN1326-1:2006

- ◆ Square root output accuracy

Output	Accuracy
≥ 50%	Same as the reference accuracy
50%~Dropping point	Reference accuracy x 50 Square root output (%)

- ◆ Power supply impact: $\pm 0.005\%/1V$
- ◆ Installation position influence: Installation position changes in the direction parallel to the diaphragm will not cause zero drift. If the installation position and the diaphragm surface change by more than 90° , zero drift within the range of 0.4KPa can be corrected by zero adjustment.
- ◆ Response time: 90ms
- ◆ Damping: Time constant can be adjusted within 0~99.9 seconds
- ◆ Filter constant: Can be adjusted within 0~160uA
- ◆ Self-stability factor: Can be adjusted within 0~2%

3.2 Dimensional drawing

Differential pressure / splint pressure transmitter

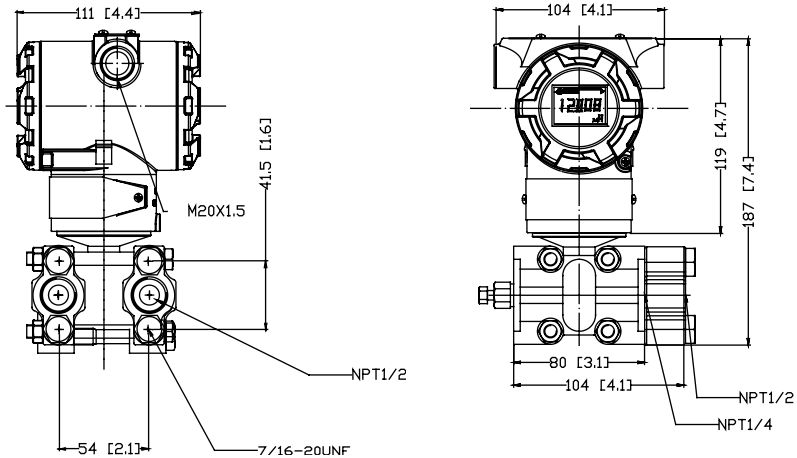

Pressure transmitter

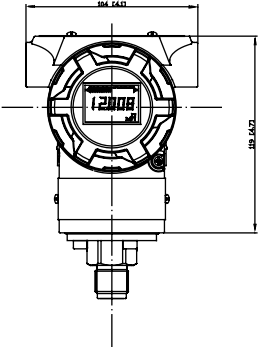
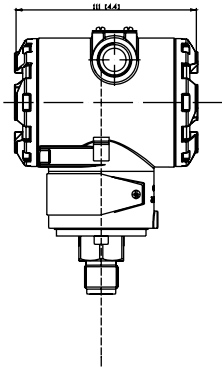

4. Installation

4.1 General installation instructions

- ◆ Installation may cause deviations in measured values. For example, when measuring in an empty container, the measured value displayed is not 0. Zero shift correction can be performed by local three buttons or by remote operation.
 - ◆ For general installation requirements of pressure pipe, please refer to the DIN 19210 standard "Fluid Measurement Method"; "differential pressure pipeline of flow measurement equipment", or related national or international standards.
- Easy to commission, install and maintain the instrument with a three-valve or five-valve set without interrupting the process.
- ◆ When installing the pressure pipe outdoors, take adequate anti-freezing protection measures, such as pipe heating.
 - ◆ Inclining installation angle of the pressure pipeline shall be at least 10%.
 - ◆ Do not use hard or sharp objects to clean or touch the diaphragm seal.
 - ◆ The maximum rotation angle of housing is 380° to ensure the best readability of the field display unit.
 - ◆ The live display can be rotated by 90° .
 - ◆ The company provides right angle or flat mounting brackets for the instrument.

4.2 On-site installation

The smart transmitters produced by our company can be installed directly on the pipeline or directly on the wall and on the instrument panel. The figure below shows different installation forms (user selectable).

Differential pressure transmitter

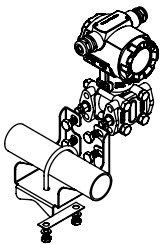

Diagram of installation using a right angle bracket

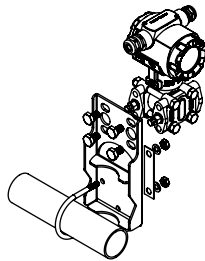
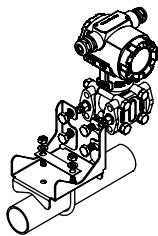
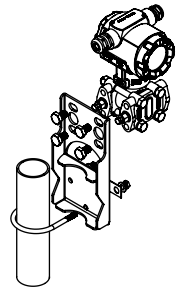
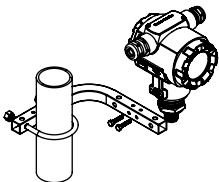

Diagram of installation using a plate bracket



Pressure transmitter



4.3 Mounting position

The correct mounting position of the transmitter on the process pipeline is related to the medium being tested. Note the following conditions in order to achieve the best installation effect:

- ◆ Prevent the transmitter from contacting with corrosive or overheated media under test.
- ◆ Prevent dross from depositing in the pressure pipe.
- ◆ The pressure pipe shall be as short as possible.
- ◆ The liquid column indenter in the pressure pipe on both sides shall be balanced.
- ◆ The pressure pipe shall be installed in a place with small temperature gradient and temperature fluctuation.
- ◆ Prevent crystallization or low temperature icing in the pressure pipe.

4.4 Installation in hazardous locations

Smart explosion-proof transmitters shall be used in hazardous locations, and smart explosion-proof transmitters are extensions of smart transmitters. The working principle and basic structure are the same as the smart transmitter.

Smart explosion-proof transmitters are available in intrinsically safe and explosion-proof versions. Explosion-proof and intrinsically safe instruments comply with provisions of GB3836.1-2000 General Requirements for Explosion-proof Electrical Equipment in Explosive Atmosphere.

The internal cavity of smart explosion-proof transmitter type can withstand an explosion, and the internal explosion does not cause explosion of the externally specified explosive mixture. Mark d conforms to GB3836.2-2000 Explosion-proof Electrical Equipment Explosion-proof Electrical Equipment. "d" in Explosive Atmosphere, the explosion-proof grade is ExdIICT6.

Smart - Transmitter intrinsically safe type: refers to the circuit system, the point spark and thermal effects generated under normal working or specified fault conditions can not ignite the specified explosive mixture, the mark ia conforms to GB3836.4-2000 Electrical Equipment Intrinsically Safe Type "i" in Explosive Atmosphere, the explosion-proof grade is Exia IICT6. The transmitter is used in conjunction with an associated equipment safety barrier installed in the control chamber to form an intrinsically safe explosion-proof system.

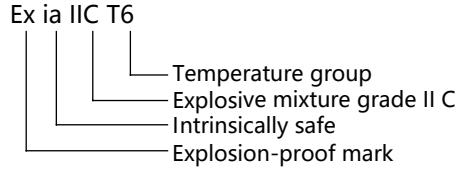
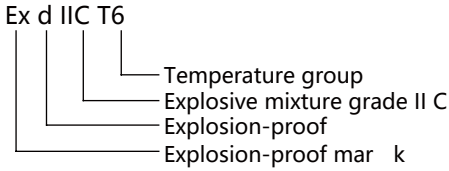

Explosion-proof structure:

The electrical components and circuit boards of all explosion-proof smart transmitters are placed inside the explosion-proof housing. Even if the instrument produces a spark internal explosion due to a fault, the transmitter housing has sufficient mechanical strength and flameproof performance. It not only does not damage the explosion-proof enclosure, also does not explode explosive mixtures outside the enclosure.

4.5 Notes for users of explosion-proof transmitters

Smart transmitter explosion-proof products are inspected by the national instrumentation explosion-proof safety supervision and inspection station (NEPSI), conforming to requirements specified in GB3836.1-2000, GB3836.2-2000 and GB3836.4-2000 standards, the product explosion-proof mark is ExdIICT6 (without acetylene) and ExiaIIC T6; users shall pay attention to the following matters when using the product:

- ◆ Users of the transmitter housing shall be grounded reliably when in use;
- ◆ Explosion-proof products are used in an ambient temperature ranging from -20 ° C to +60 ° C;
- ◆ Explosion-proof products are used on site, and observe the principle of “open the cover after power off” during maintenance;
- ◆ Intrinsically safe products shall be matched with safety barriers LB987S,

MTL787S, E787 etc. recognized by the explosion-proof inspection agency when installed on site to constitute an intrinsically safe explosion-proof system. In order to install with other types of safety barriers, it is necessary to obtain approval from an explosion-proof inspection agency;

- ◆ Connection cable between the transmitter and the safety barrier's intrinsic end is a two-core shielded cable (the cable shall have a cable sheath). The cross-sectional area of the core wire is $\geq 0.5\text{mm}^2$, and the shielding layer is grounded at a single end in a safe place and insulated from the product casing; the cable wiring shall eliminate influence of electromagnetic interference as much as possible, and cable distribution parameter shall be controlled within $0.06\mu\text{F}/1\text{mH}$.
- ◆ The safety barrier shall be installed in a safe place. The installation, use and maintenance shall comply with the safety barrier instruction manual.

- ◆ Users are not allowed to change the electrical components and system matching status of the product at will.
- ◆ The installation, use and maintenance of the product shall also comply with the product manual GB3806.15-2000 "Electrical Equipment for Explosive Gas Atmosphere" Part 15: Electrical installation in hazardous areas (mineral removal)" and relevant provisions in GB50058-1992 "Electric Equipment Design Specification in Explosion and Fire Hazard Environment".
- ◆ Lead-in cable of the flameproof product shall meet requirements of $\varphi 8 \sim \varphi 8.5\text{mm}$. Tighten the compression nut during on-site use to make the seal ring hold the cable tightly.
- ◆ The product has a redundant inlet, which shall be blocked with the plug provided by our company.

4.6 Measurement method

- ◆ Liquid measurement:

When measuring flow rate of the liquid, the pressure tap shall be open on the side of the process pipeline to avoid cross sedimentation. At the same time, the transmitter shall be installed beside or below the pressure tap to allow air bubbles to escape into the process pipeline.

- ◆ Gas measurement:

When measuring gas flow, the pressure tap shall be open at the top or side of the process pipeline. And the transmitter shall be placed beside or above the process piping so that accumulated liquid can easily flow into the process pipeline.

- ◆ Steam measurement: When measuring steam flow, the pressure port is open on the side of the process pipeline, and the transmitter is installed under the pressure port so that the condensate can be filled in the pressure pipe.

It shall be noted that when measuring steam or other high temperature media, the temperature shall not exceed temperature limit of the transmitter.

When medium to be measured is steam, the pressure pipe should be filled with water to prevent the steam from directly contacting the transmitter. Since volume change of the transmitter is negligible during operation, there is no need to install a condensing tank.

Note: A transmitter with release valve is equipped in the pressure chamber and pressure tapping shall be open on the side of the process pipeline. When the measured medium is liquid, discharge valve of the transmitter shall be installed to discharge gas that has penetrated in the measured medium. When measured medium is gas, discharge valve of the transmitter shall be installed below to discharge accumulated liquid.

◆ Level measurement: The differential pressure transmitter used to measure liquid level is actually the static head for measuring liquid column. This pressure is determined by the level and specific gravity of liquid. The size is equal to liquid level above the pressure tap multiplied by specific gravity of the liquid, regardless of volume or shape of the container.

(a) Level measurement of open container

When measuring liquid level of open container, the transmitter is placed close to bottom of the container to measure pressure corresponding to the liquid level above it. Pressure at the tank level is connected to the high-pressure side of the transmitter and the low-pressure side is open to the atmosphere. If the lowest level of measured level changes is above the transmitter installation, the transmitter shall be positively migrated.

(b) Level measurement of closed container

In a closed container, pressure of the container above the liquid affects pressure at bottom of the container. Therefore, pressure at bottom of the container is equal to liquid level multiplied by specific gravity of the liquid plus pressure of the closed container.

In order to measure true level, pressure of the container shall be subtracted from the measured bottom pressure of the container. Thus, open pressure tap on top of the container and connect to the low-pressure side of the transmitter so that the pressure in the container acts on both the high and low-pressure side of the transmitter. As a result, differential pressure obtained is proportional to product of the liquid level and specific gravity of the liquid.

◆ Dry pressure connection

If the gas above the liquid does not condense, the connection pipe on the low-pressure side of the transmitter will remain dry. This condition is called a dry pressure connection.

The method of determining measurement range of the transmitter is the same as the method of open container liquid level.

◆ Wet pressure connection

If the gas on the liquid condenses, the liquid will gradually accumulate in the pressure pipe on the low-pressure side of the transmitter, which will cause measurement error. In order to eliminate this error, a certain liquid is previously filled in the low-pressure side of the transmitter, which is called a wet pressure connection.

(c) Reducing error

Pressure tube connects the transmitter to process pipeline and transfers pressure at the pressure tap on the process line to the transmitter.

Causes of errors during pressure transmission are as follows:

- ◆ leakage;
- ◆ Loss of wear (when using special detergent);
- ◆ There is gas in the liquid pipeline (causing pressure head error);
- ◆ Accumulate liquid in the gas pipeline (causing pressure head error);
- ◆ Density between two pressure pipes is different due to temperature difference (causing pressure head error).

(d) Method of reducing error is as follows:

- ◆ The pressure pipe shall be as short as possible;
- ◆ When measuring liquid or steam, the pressure guiding pipe shall be connected upwards to the process pipeline, and the slope shall be not less than 1/12;
- ◆ For gas measurement, the pressure guiding pipe shall be connected downwards to the process pipeline, and the slope shall be not less than 1/12;
- ◆ Liquid pressure guiding pipeline shall be laid to avoid high points in the middle, and the gas pressure pipe shall be laid to avoid low points in the middle;
- ◆ The two pressure pipes shall maintain the same temperature;
- ◆ To avoid friction influence, diameter of the pressure pipe shall be large enough;
- ◆ There shall be no gas in the liquid-filled pressure pipe;
- ◆ When using spacer liquid, liquid on both sides of the pressure pipe shall be the same;

5. Connection

5.1 Connecting device

Warning

There is a risk of electric shock!

When operating voltage is higher than 35V DC: There is dangerous voltage on the terminal block.

▲ Do not open cover of the live instrument in a humid environment.

Warning: Connection errors can result in limited electrical safety!

▲ There is a risk of electric shock / explosion in a danger zone!

▲ When using measuring equipment in a hazardous area, it shall be installed in accordance with relevant national standards and regulations, as well as the Safety Instructions or the Installation/Control Icons.

▲ Devices with built-in overvoltage protection unit shall be grounded.

▲ With polarity reverse connection, radio frequency interference (HF), over voltage peak protection circuit.

5.2 Wiring method

5.2.1 Wiring diagram

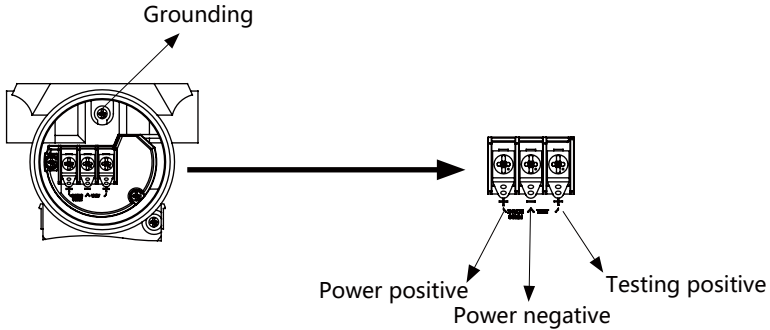

5.2.2 Cable specifications

- ◆ The company recommends to use shielded, double-core double-twisted cable
- ◆ Wire core cross-section of block terminal: 0.5...2.5mm²
- ◆ Cable outer diameter: 5...9mm

5.2.3 Shielding / potential balance

- ◆ When both ends of the shielding layer are grounded (connected to the control and equipment respectively), it is possible to obtain the best shielding effect to prevent interference impact on the measurement. When there is strong equalizing current in the factory, the shielding layer is only connected at one end. It is recommended to ground the transmitter end.
- ◆ When using in a hazardous area, comply with applicable regulatory requirements.

Additional technical data and operating manuals in the separate explosion-proof manual are standard documents for all explosion-proof (Ex) systems.

6. Commissioning

6.1 Local three-button commissioning

6.1.1 Three-button position diagram

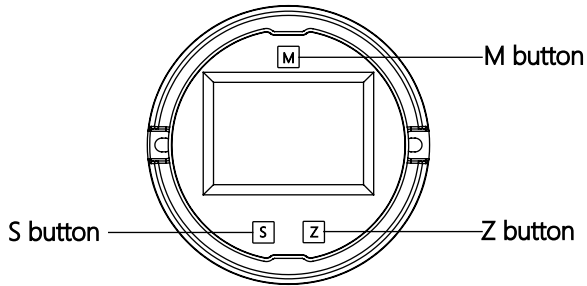

6.1.2 Introduction to display structure

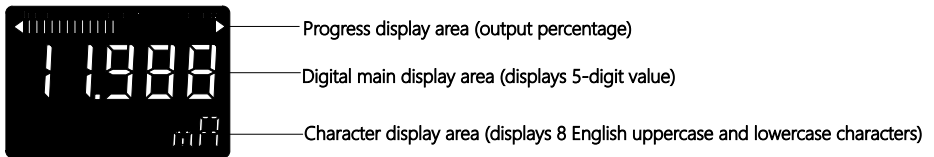

6.1.3 Three-button debugging diagram

Common parameter setting

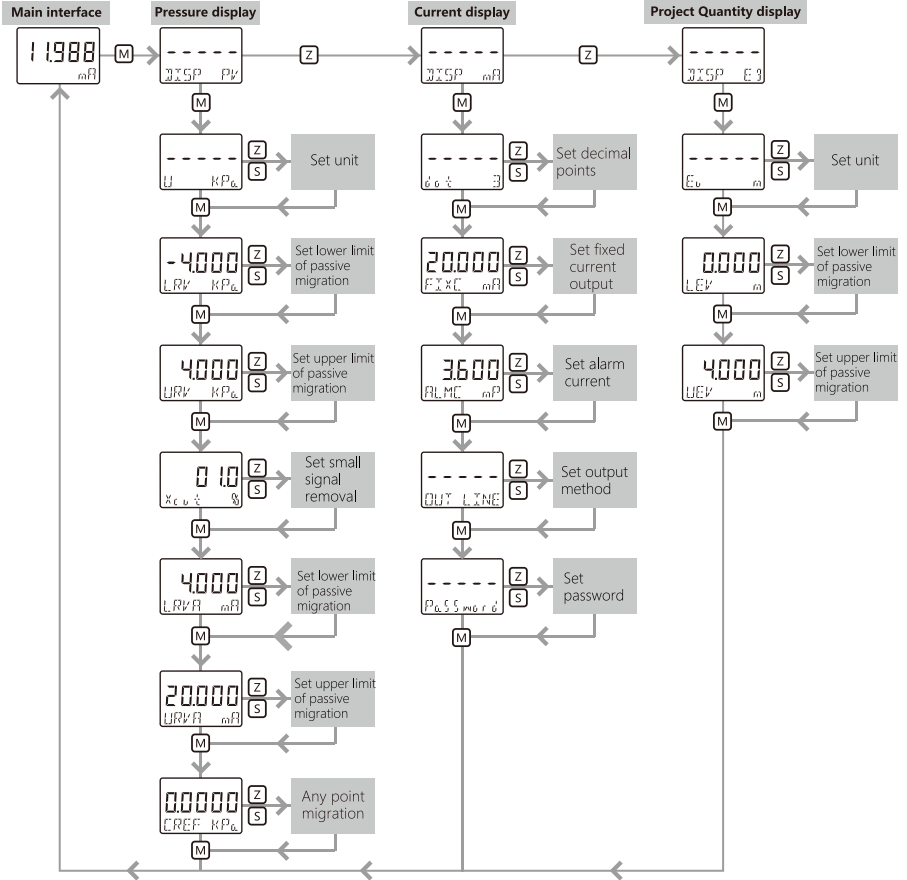

Pressure correction parameter settings

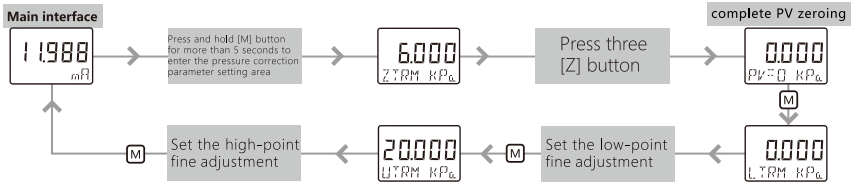

Factory data reset

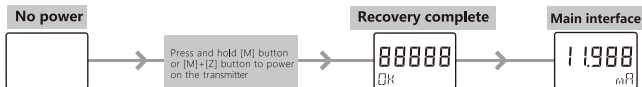

7. Troubleshooting of transmitter maintenance

7.1 Instrument maintenance

7.1.1 Soft maintenance

The HART smart transmitter is a smart product with parameters open to the user. Users can adjust zero point, set range, set damping, and even recalibrate according to the actual situation. When core parameters are modified or confusing, it will cause a soft fault. In this case, please refer to the previous section for debugging and return to normal operation.

When the actual situation needs to be re-zeroed, please remove the case cover, adjust with buttons, or use software to debug directly. The speciPc adjustment method is carried out according to the above-mentioned button operation description and software debugging method.

7.1.2 Hard maintenance

Generally speaking, the sensor components, main circuit board and display head are not repairable on site. Hardware maintenance of the user is limited to circuit connection inspection, transmitter cleaning, replacement, and block terminal inspection.

◆ Inspection of process sensor body

Note the following:

- (1) Remove the transmitter from operating points before disassembling the sensor body.
- (2) Temperature and pressure circulation experiments shall be performed after reassembly to ensure accuracy of the transmitter.
- (3) Remove four bolts to disassemble the pressure chamber.
- (4) Clean the isolation diaphragm with a soft cloth or a mild detergent and rinse with water.
- (5) To facilitate installation, the pressure chamber and Pttings can be rotated or mounted reversely.

◆ Block terminal inspection

Unscrew the rear cover to expose the terminal block. Unscrew the two positioning screws and remove the terminal cover to expose the board. Check if the wiring board connection is correct and reliable. It is mainly concentrated on assembly of the feedthru capacitor and the test diode.

7.2 Troubleshooting

In the case of a transmitter failure, the following steps can help identify cause of the problem. It also helps determine if it is necessary to remove for repair. These materials help diagnose and repair the three basic symptoms of the problem. Firstly handle conditions that are most easily checked for each symptom. Please contact our service center if it is difficult to repair.

7.3 Display error code



— Current is not calibrated



— Sensor error

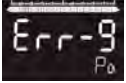

— Exceeding the display range

Terms of Warranty Service

Dear users:

Thank you for using our products. In order to make our service more satisfying, please read this regulation carefully and take care of this service warranty card. This service warranty card shall be provided while seeking for after-sales service.

I. Warranty description:

1. Warranty period of this product is one year, which is subject to warranty period published on the website.
2. Please consider carefully when purchasing, if there is no quality problem, it shall not be returned.

II. No after-sales service is provided in any of the following cases, whether or not it is within the warranty period;

1. Artificial surface corrosion, cracks or bumps, and damage caused by abnormal installation, use and maintenance.
2. Delivery period of the product exceeds warranty period.
3. Repaired by an unauthorized service provider or technician or disassembled by the user.

III. The company reserves rights to make final interpretations and changes to these terms of service.